

Note:

1. Min. holding Strength: 95% RTS of OPGW;
2. Hot-dip galvanized to ISO 1461;
3. All dimensions are in millimeters;
4. The diameter and RTS of OPGW:11.50mm, 45.1kN;
5. The stranding direction of OPGW outer layer is right hand;
6. Version numbers may be supplemented to our products' models.

7	Earth Bonding Lead	JDX-95-2000BB	Aluminum	1	
6	Parallel Groove Clamp	JBL-16-120	Aluminum Alloy	1	
5	Structural Reinforcing Rods	ONN	Al.-Clad Steel	1	
4	Dead-End Component	ONW	Al.-Clad Steel	1	
3	Thimble Clevis	TC-7	Galv. Steel	1	70kN
2	Extension Rod	YL-1040	Galv. Steel	1	100kN
1	Hanger	UB-2090	Galv. Steel	1	120kN
Item	Description	Cat. No.	Material	QTY	U.T.S

General Tolerance		
<=30	±1.5mm	ANGLE: ±
>30	±5%	
Weight	±15%	
Drawing	Alex	2020-01-29
Checked	Jeff	2020-01-29
Approved	Felix	2020-01-29

Tension Set for OPGW
TYPE: ONP-050-1150



Jiangsu Zhongtian
Technology Co., Ltd.

Mass		Scale	NTS
JSF-105653-2		REV	B

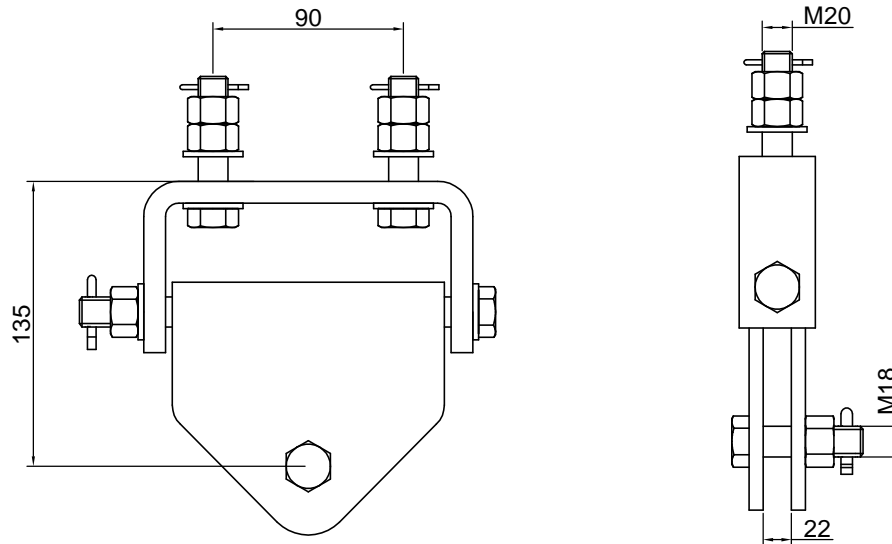

Note:

1. Material: Galvanized steel, the cotter-pin is stainless steel;
2. Galvanized to ISO 1461;
3. Minimum failing load: 120kN;
4. All dimensions are in millimetres.

General Tolerance			Hanger UB-2090				
<=30	±1.5mm	ANGLE:					
>30	±5%	±					
Weight	±15%			Mass		Scale	NTS
Drawing	Alex	2020-01-29	Jiangsu Zhongtian Technology Co., Ltd.	JSF-122007	REV	A	
Checked	Jeff	2020-01-29					
Approved	Felix	2020-01-29					

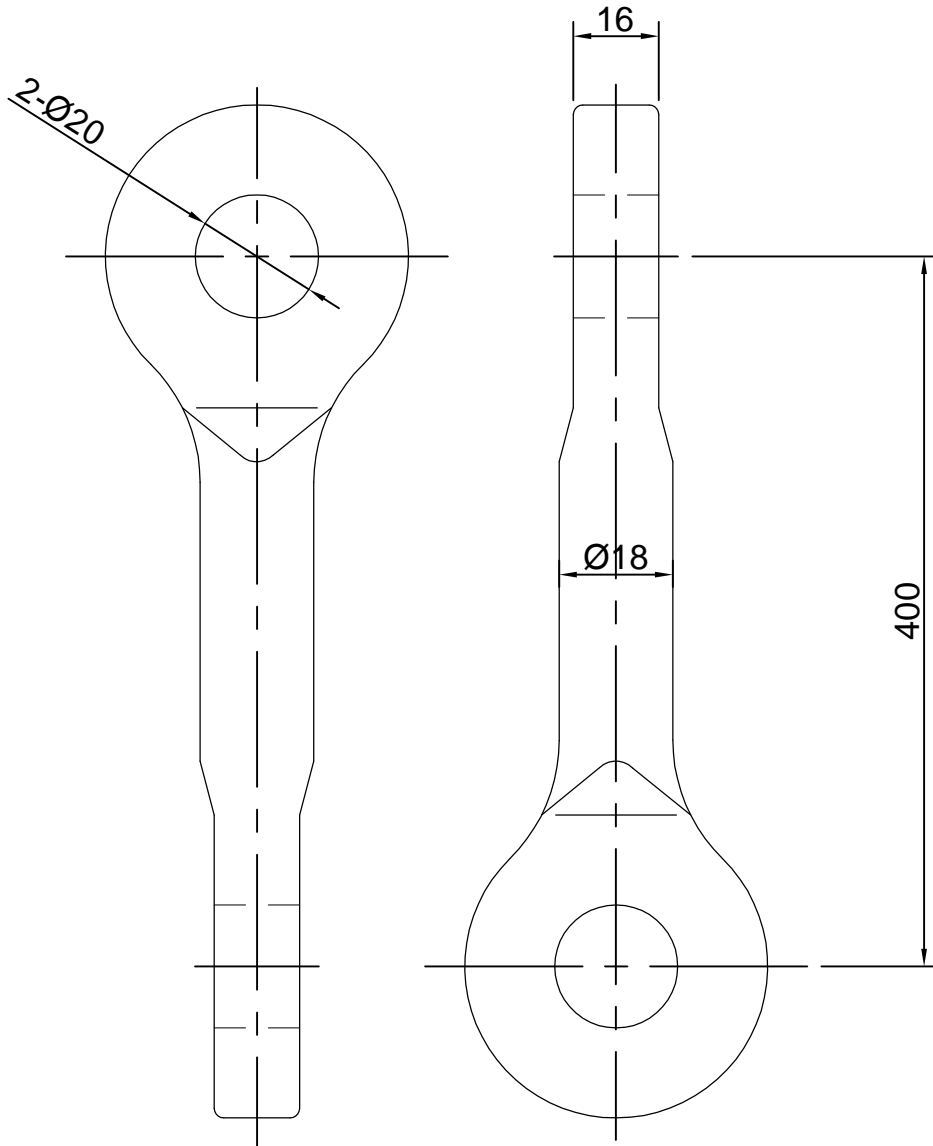

Note:

1. Material: Galvanized Steel;
2. Minimum breaking load: 100kN;
3. Galvanized to ISO 1461;
4. All dimensions are in mm;
5. Version numbers may be supplemented to our products' models.

General Tolerance			Extension Rod TYPE:YL-1040	 ZTT 中天科技				
<=30	±1.5mm	ANGLE: ±						Jiangsu Zhongtian Technology Co., Ltd.
>30	±5%			JSF-111377	REV	A		
Weight	±15%							
Drawing	Alex	2020-01-29						
Checked	Jeff	2020-01-29						
Approved	Felix	2020-01-29						

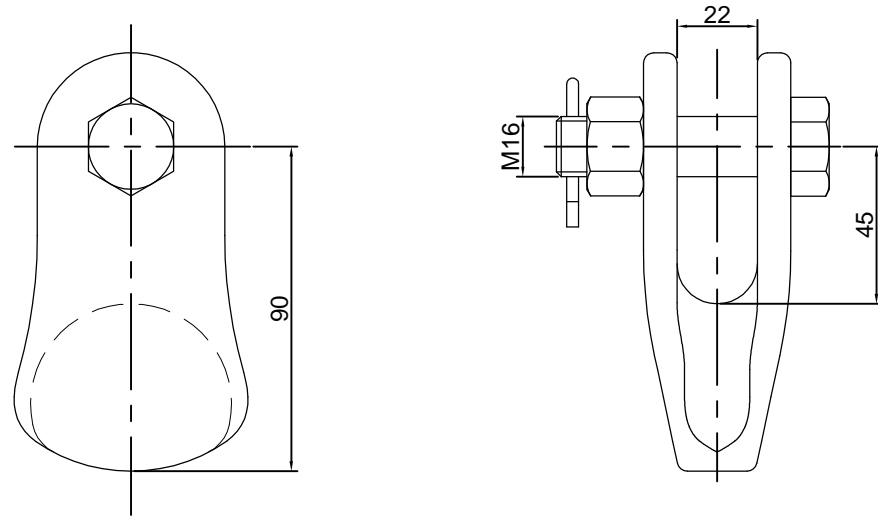

Note:

1. Material: Galvanized steel, the cotter-pin is stainless steel;
2. All ferrous parts are hot-dip galvanized as per ISO 1461;
3. Minimum failing load: 70kN;
4. All dimensions are in millimetres;
5. Version numbers may be supplemented to our products' models.

General Tolerance			Thimble Clevis TYPE: TC-7					
<=30	±1.5mm	ANGLE:						
>30	±5%	±						
Weight	±15%			Mass		Scale	NTS	
Drawing	Alex	2020-01-29	Jiangsu Zhongtian Technology Co., Ltd.	JSF-121107			REV	A
Checked	Jeff	2020-01-29						
Approved	Felix	2020-01-29						

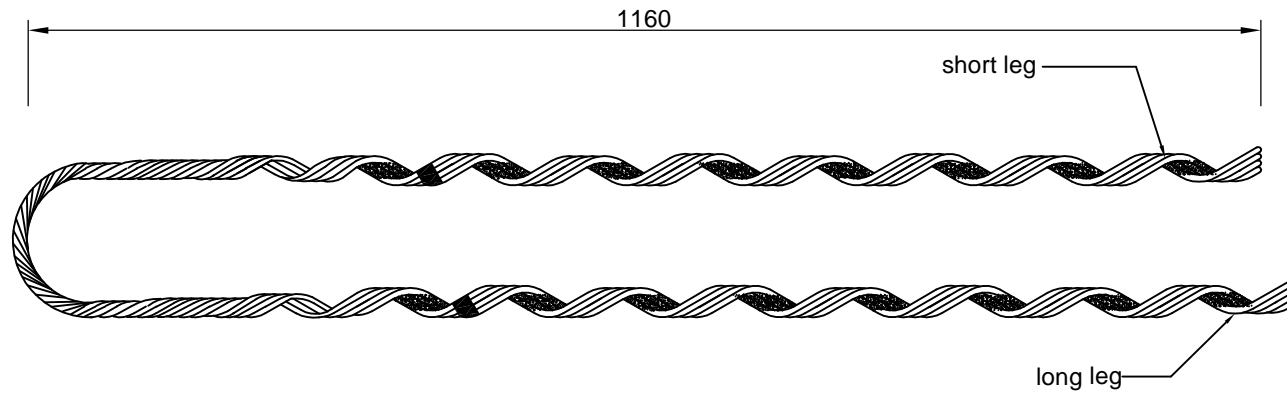

Note:

1. Material: Aluminium clad steel;
2. Rod diameter: 3.5mm;
3. All dimensions are in millimeters;
4. Version numbers may be supplemented to our products' models.

General Tolerance			Dead-End Component TYPE: ONW	 ZTT 中天科技			
<=30	±1.5mm	ANGLE: ±					
>30	±5%						
Weight	±15%						
Drawing	Alex	2020-01-29	Jiangsu Zhongtian Technology Co., Ltd.	Mass		Scale	NTS
Checked	Jeff	2020-01-29					
Approved	Felix	2020-01-29		JSF-105653-7	REV	A	

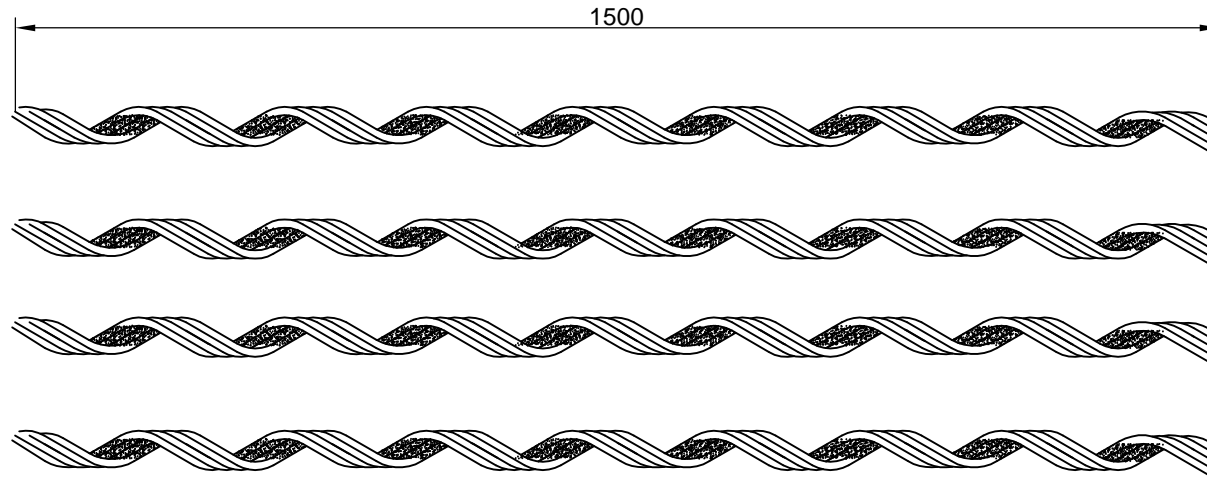

Note:

1. Material: Aluminium clad steel;
2. Rod diameter: 2.5mm;
3. All dimensions are in millimeters;
4. Version numbers may be supplemented to our products' models.

General Tolerance			Structural Reinforcing Rods TYPE: ONN				
<=30	±1.5mm	ANGLE: ±					
>30	±5%		Jiangsu Zhongtian Technology Co., Ltd.	Mass		Scale	NTS
Weight	±15%			JSF-105653-8	REV	A	
Drawing	Alex	2020-01-29					
Checked	Jeff	2020-01-29					
Approved	Felix	2020-01-29					

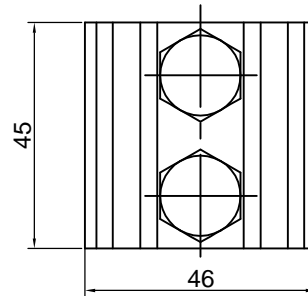
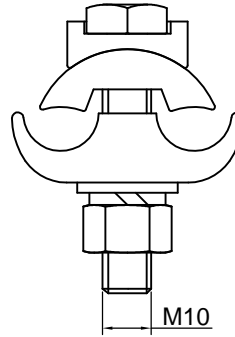

Note:

1. Material: The clamp body is aluminium alloy,
the other parts are galvanized steel;
2. All dimensions are in millimeters;
3. All ferrous parts are hot-dip galvanized as per ISO 1461;
4. Version numbers may be supplemented to our products' models.

General Tolerance			Parallel Groove Clamp TYPE:JBL-16-120			
<=30	±1.5mm	ANGLE: ±				
>30	±5%					
Weight	±15%		Mass		Scale	NTS
Drawing	Alex	2020-01-29	Jiangsu zhongtian Technology Co.,Ltd.	JSF-124003	REV	A
Checked	Jeff	2020-01-29				
Approved	Felix	2020-01-29				

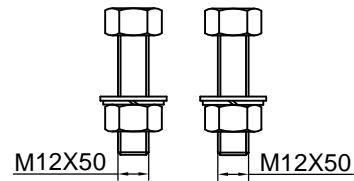
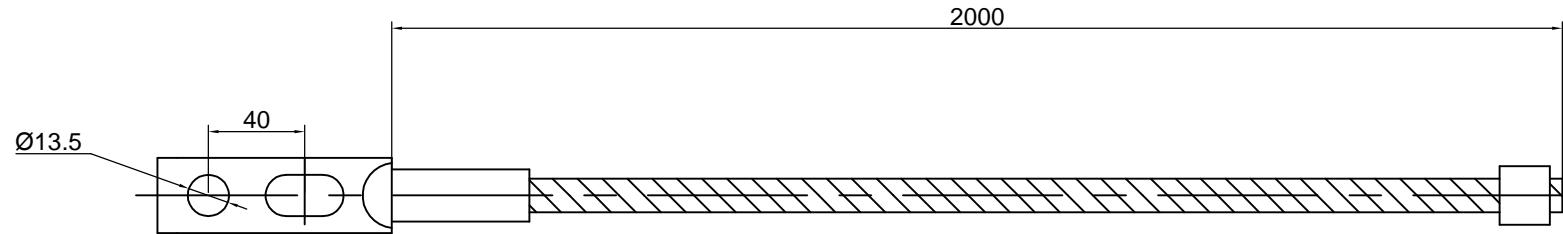

- Note:
1. Material: Aluminium, the bolt assembly is galvanized steel;
 2. All dimensions are in millimeters;
 3. Version numbers may be supplemented to our products' models.

General Tolerance			Earth Bonding Lead TYPE:JDX-95-2000BB				
<=30	±1.5mm	ANGLE: ±					
>30	±5%						
Weight	±15%			Mass		Scale	NTS
Drawing	Alex	2020-01-29	Jiangsu Zhongtian Technology Co., Ltd.	JSF-138049	REV	A	
Checked	Jeff	2020-01-29					
Approved	Felix	2020-01-29					